

Saída em Eixo Maciço
(N2N1)

Saída em Eixo Vazado
(N2V1)

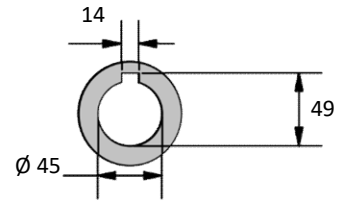

Demais cotas permanecem iguais

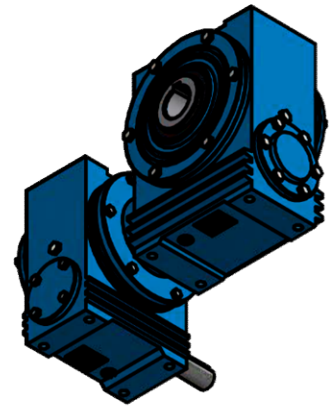
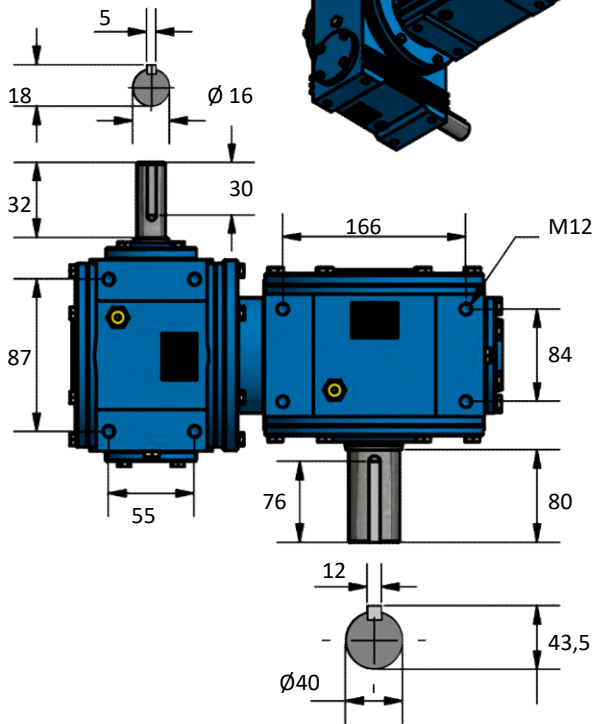
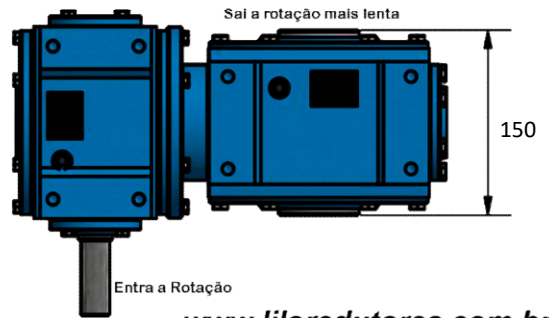
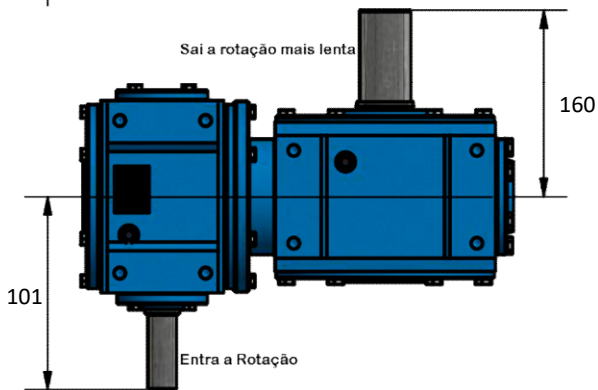
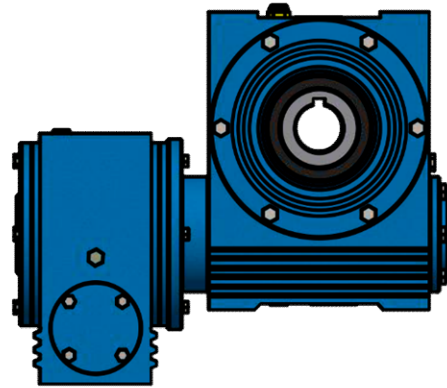
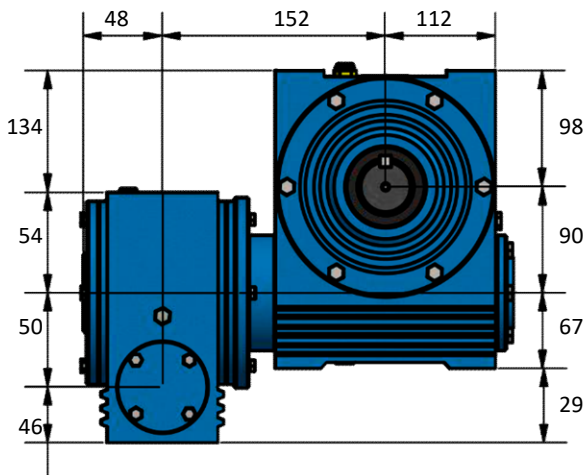

www.liloredutores.com.br



Código do produto
090/050-(N2N1-e-N2V1)

Divisão de Engenharia
Redutores LiLo

Edição
1ª

Formato
A4