

Saída em Eixo Maciço  
(N2N1)

Saída em Eixo Vazado  
(N2V1)

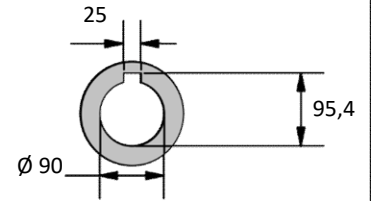

Demais cotas permanecem iguais

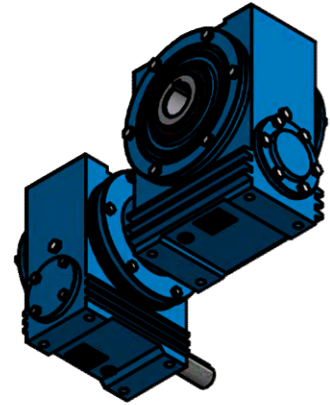
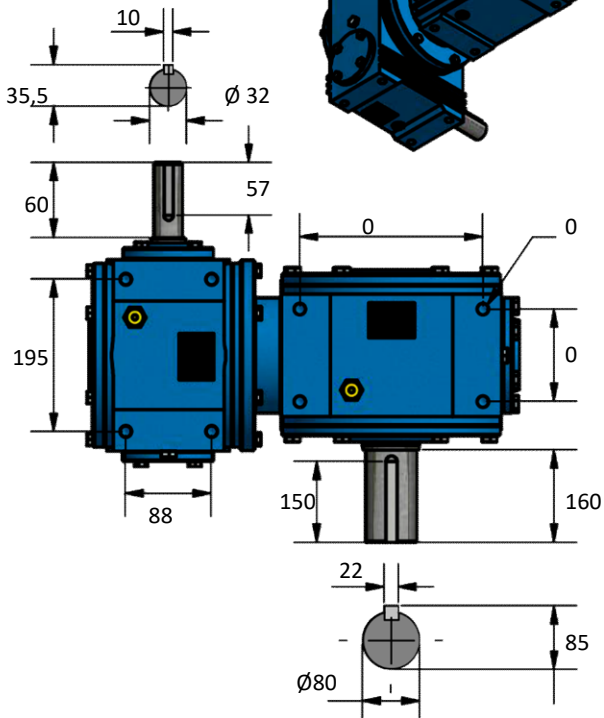
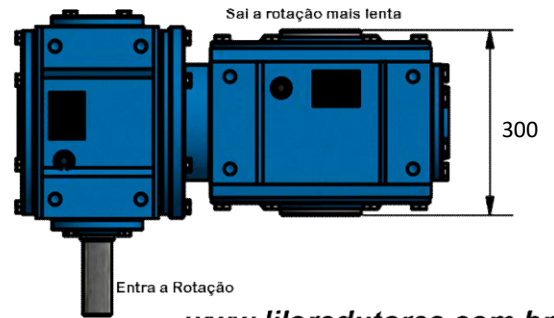
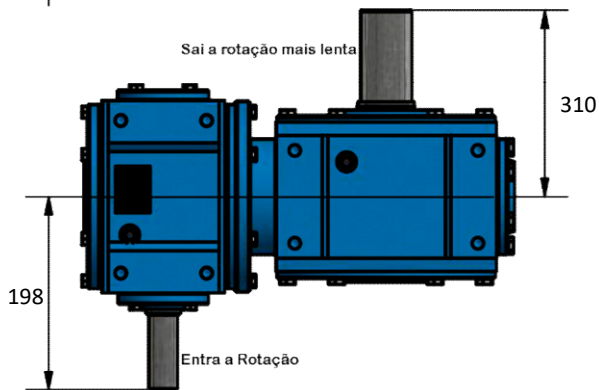
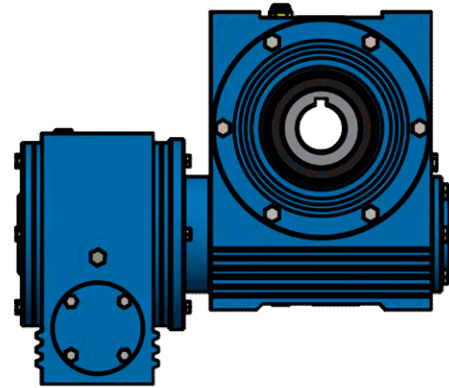
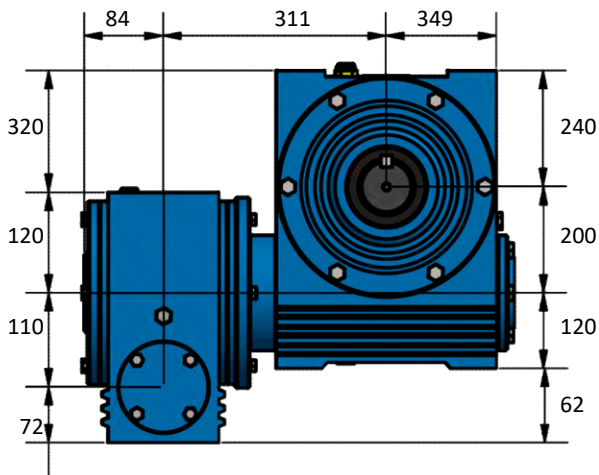

[www.liloredutores.com.br](http://www.liloredutores.com.br)



Código do produto  
200/110-(N2N1-e-N2V1)

Divisão de Engenharia  
Redutores LiLo

Edição  
1ª

Formato  
A4