

ESTE MOTOREDUTOR PODE TRABALHAR NESSAS POSIÇÕES

P1

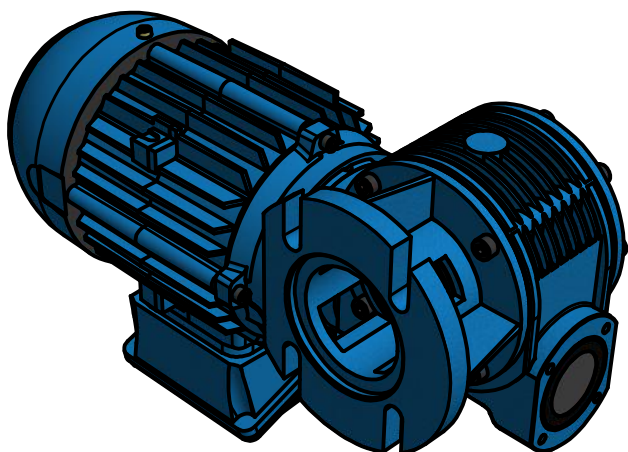

P2

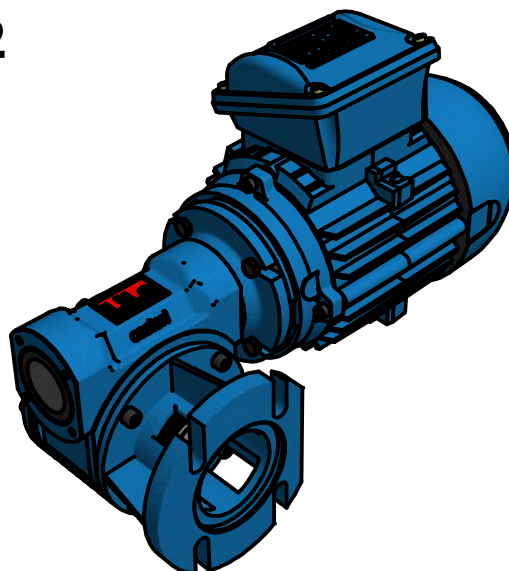

P3

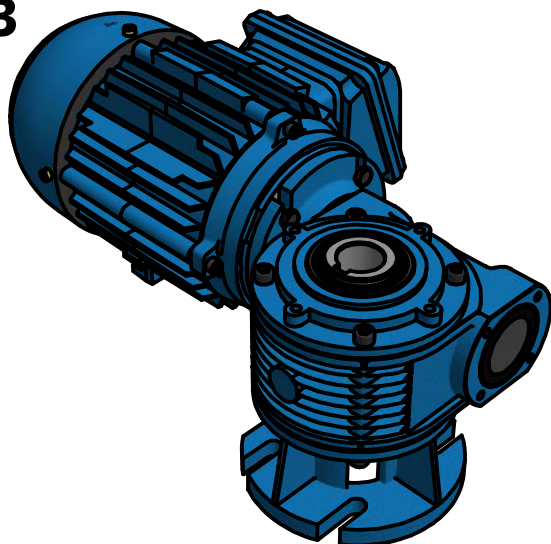

P4

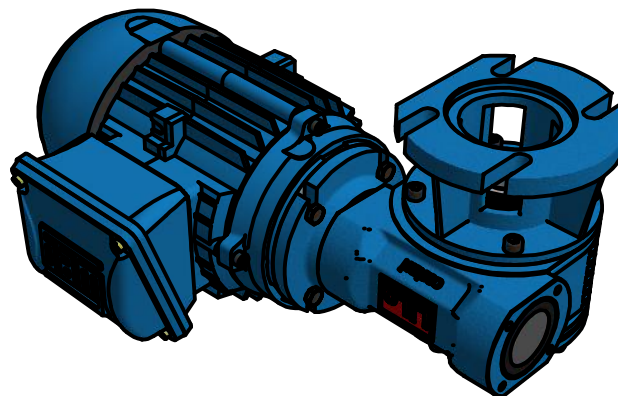

P5

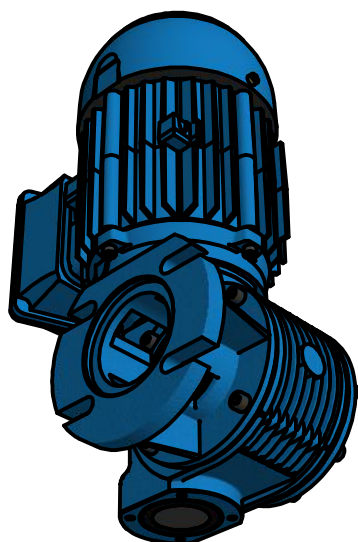

P6

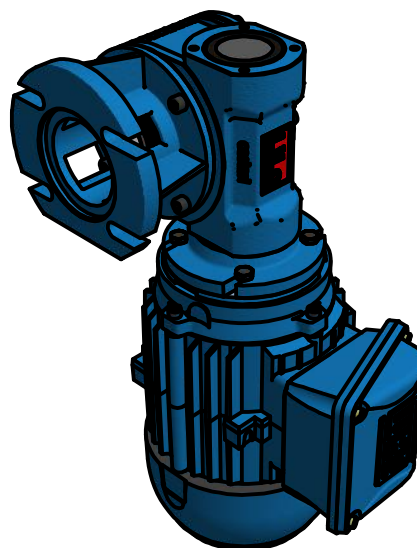

www.liloredutores.com.br



Código do produto
Motoredutor Alumag V3

Divisão de Engenharia
Redutores LiLo

Edição
1ª

Formato
A4